

T-Neck Right (side of collar)  
3"W x 1"H



T-Neck Left (side of collar)  
3"W x 1"H



T-Neck Center (of collar)  
3"W x 1"H



Upper Front Neck  
2.5"W x 2.5"H

Right Sleeve Shoulder  
3.5"W x 4"H

Left Sleeve Shoulder  
3.5"W x 4"H

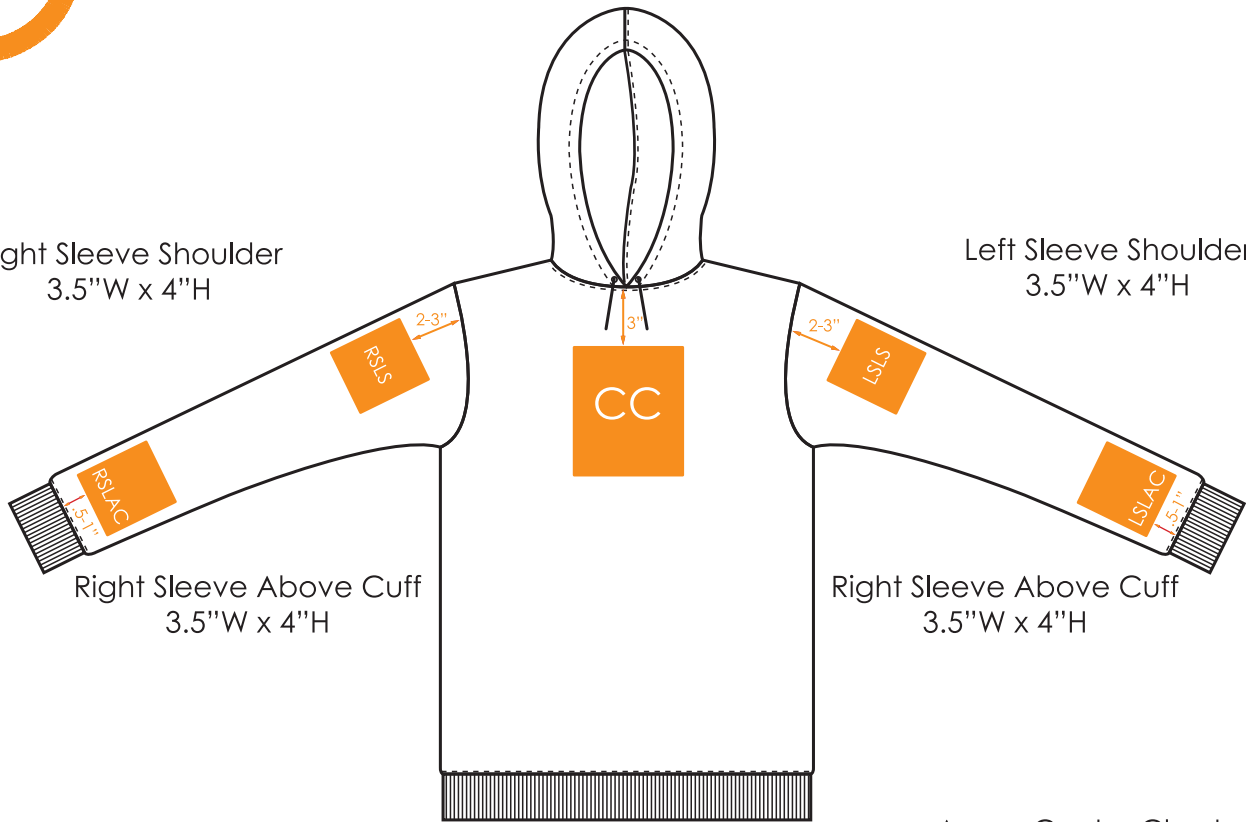

Right Sleeve Above Cuff  
3.5"W x 4"H

Left Sleeve Above Cuff  
3.5"W x 4"H

Center Chest  
4.5"W x 5.3"H

Apron Center Chest  
4.5"W x 5.3"H



Left Chest Above Pocket  
4.5"W x 5.3"H



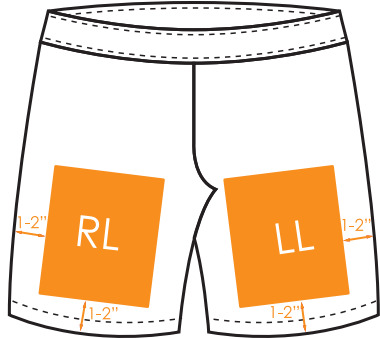

Right Leg  
4.5"W x 5.3"H

Left Leg  
4.5"W x 5.3"H

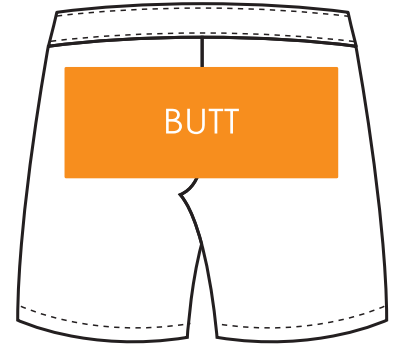

Butt  
9.3"W x 4"H

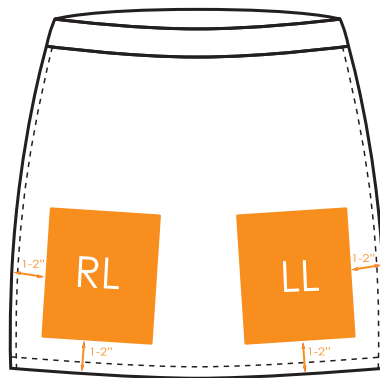

Right Leg  
4.5"W x 5.3"H

Left Leg  
4.5"W x 5.3"H

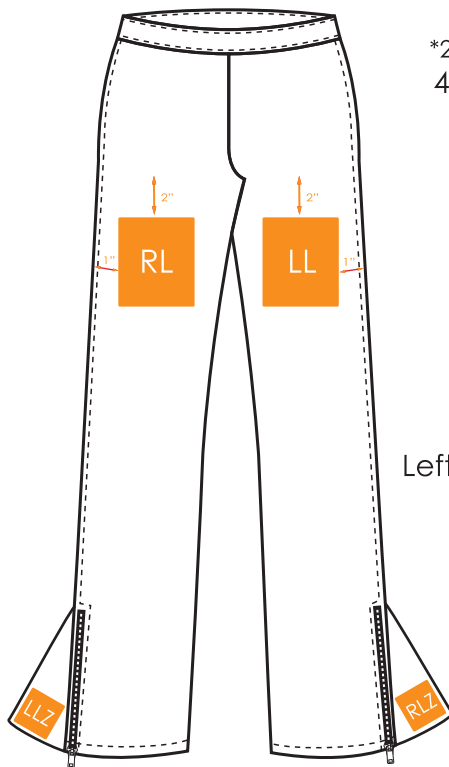

Right Leg  
\*2" below crotch  
4.5"W x 5.3"H

Left Leg  
\*2" below crotch  
4.5"W x 5.3"H

Left Leg On Zip Gusset  
(by ankle)  
2"W x 2"H

Left Leg On Zip Gusset  
(by ankle)  
2"W x 2"H

Butt  
9.3"W x 4"H

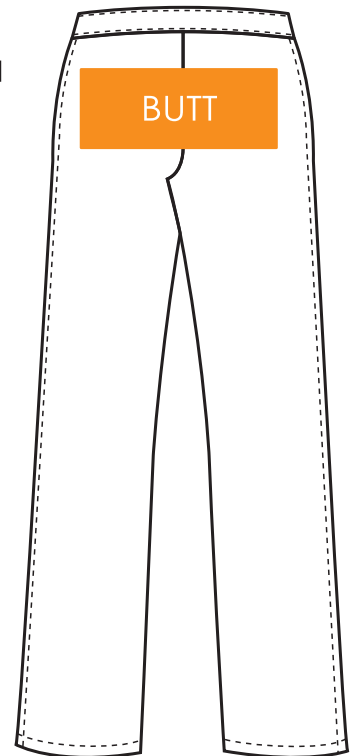

Hat Back  
\*Over back strap  
3.5"W x 1.1"H

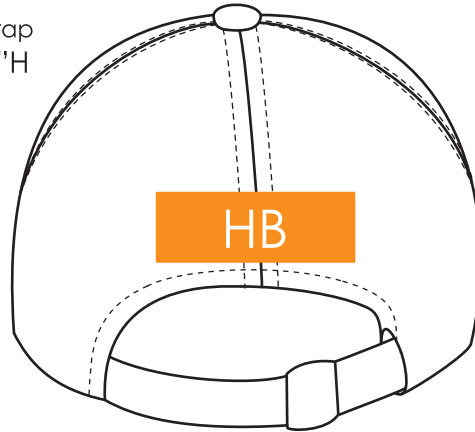

Hat Back  
3.5"W x 1.1"H

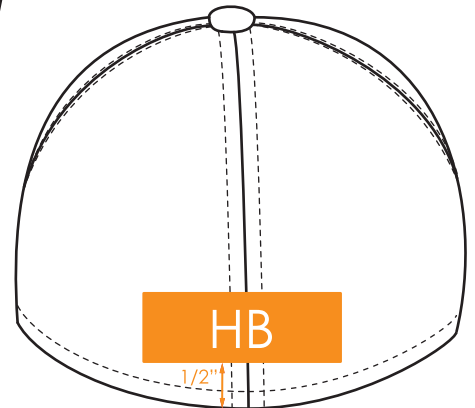

Hat Front  
4"W x 2.4"H



Hat Side (Left or Right)  
\*centered within the side panel  
2"W x 2.4"H

Visor Hat Front  
3"W x 1.1"H

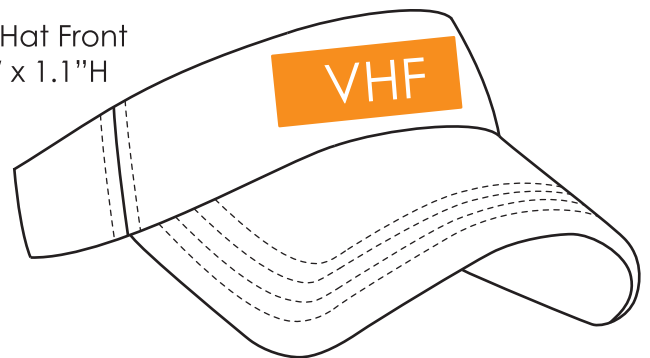

Stocking Hat Front  
4"W x 2.4"H

Headband/Hat band Center Front  
4"W x 2.4"H

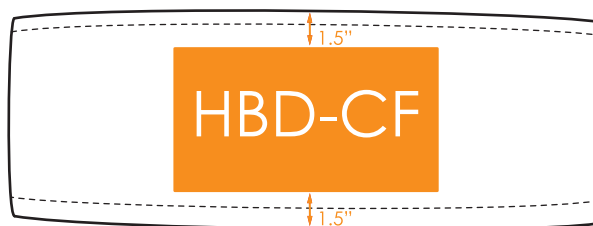

Bag Side  
3.5"W x 4"H

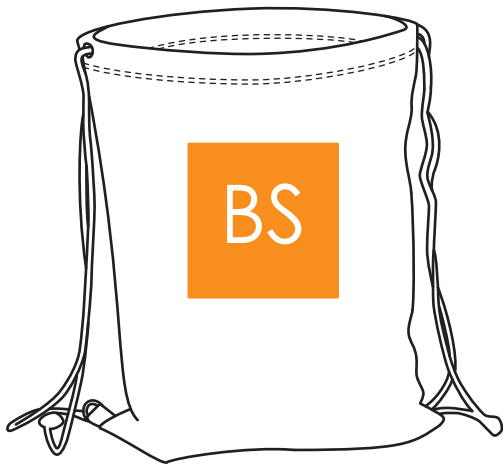

Bag Flap  
3.5"W x 4"H

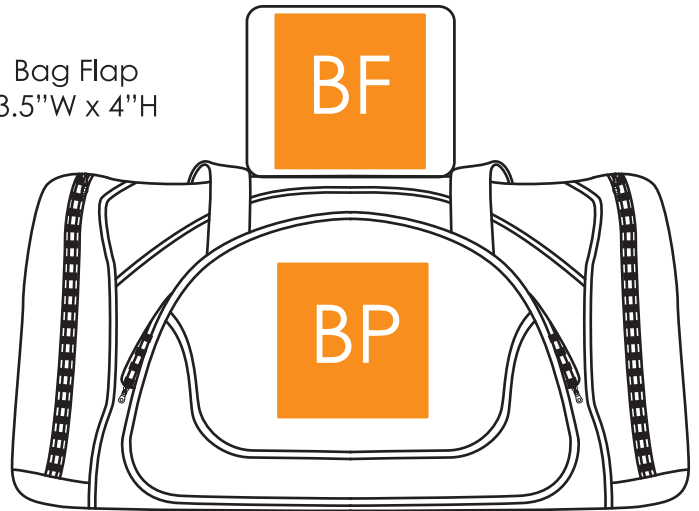

Bag Flap  
3.5"W x 4"H

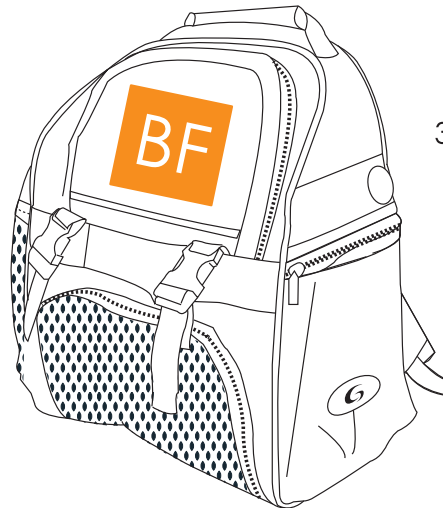

Right (or Left) End of Bag  
3.5"W x 4"H



Bag Pocket  
3.5"W x 4"H

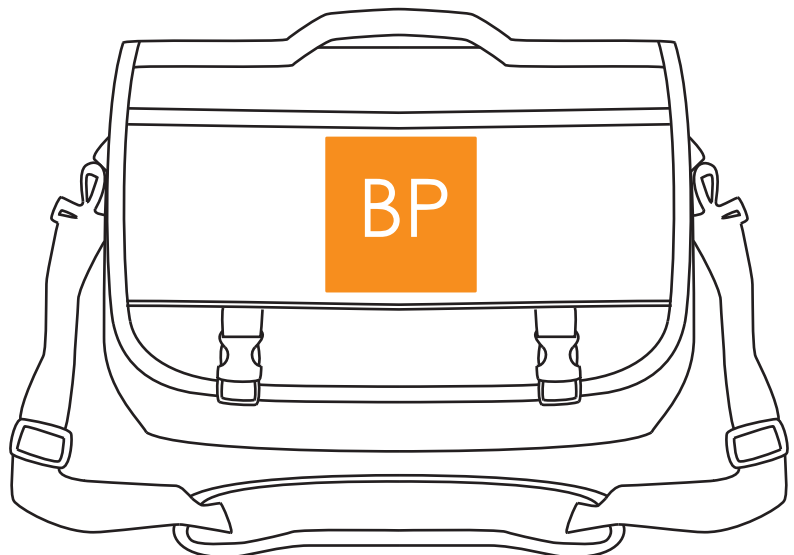

## Afghan

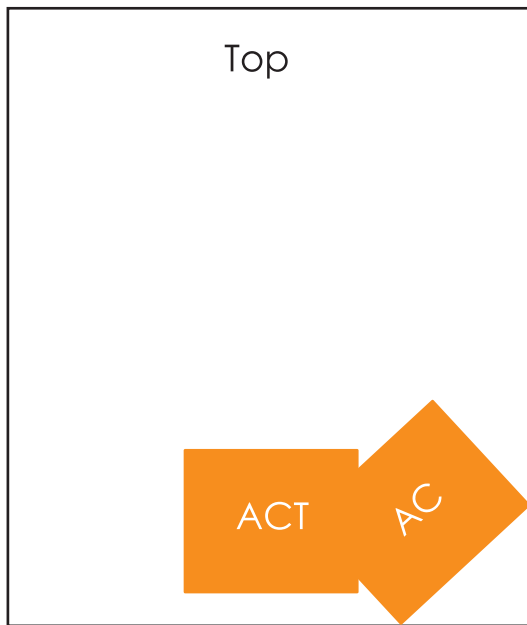

Afghan Center  
10.7"W x 9.3"H

Afghan Corner  
\*Sewn at an angle  
10.7"W x 9.3"H

## Blanket

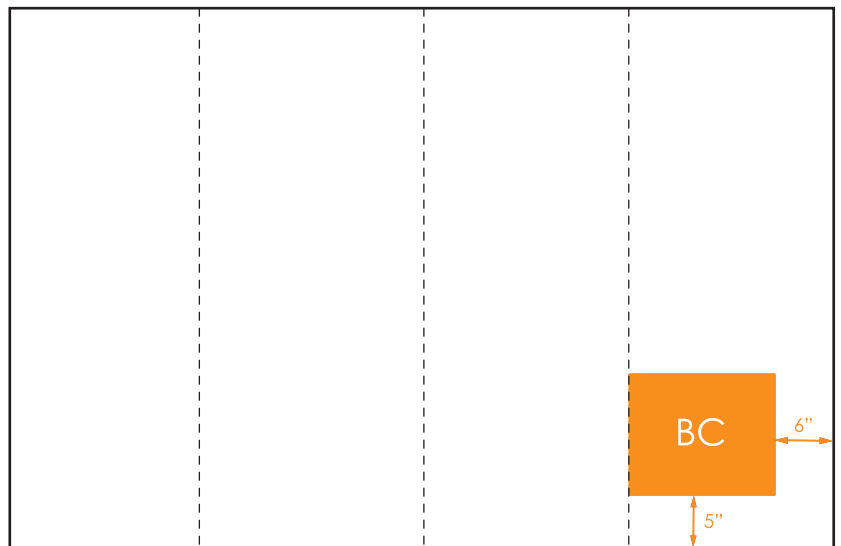

Blanket Corner  
\*Parallel on long side  
\*Center of design should be 6" from right side of your blanket and 5" up from the bottom  
10.7"W x 9.3"H

## Towel

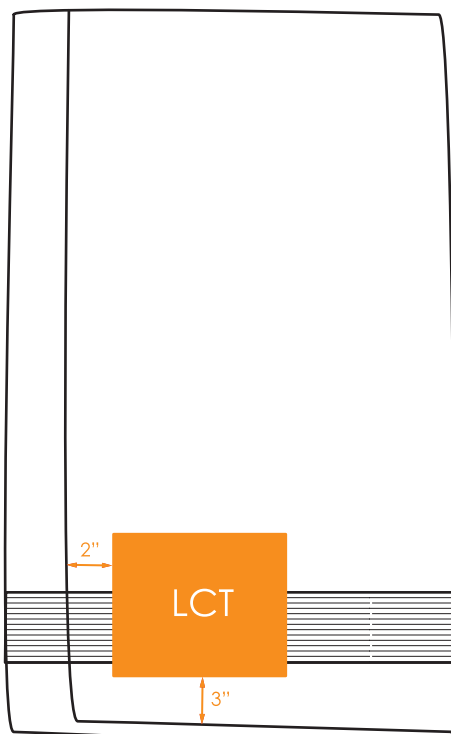

Left Corner Towel  
\*The bottom of the design should be 3" up from the bottom of the towel and 2" over from the edge  
10.7"W x 9.3"H